

ASSEMBLY INSTRUCTIONS - CANTILEVER
PARTS/REQUIREMENTS LIST

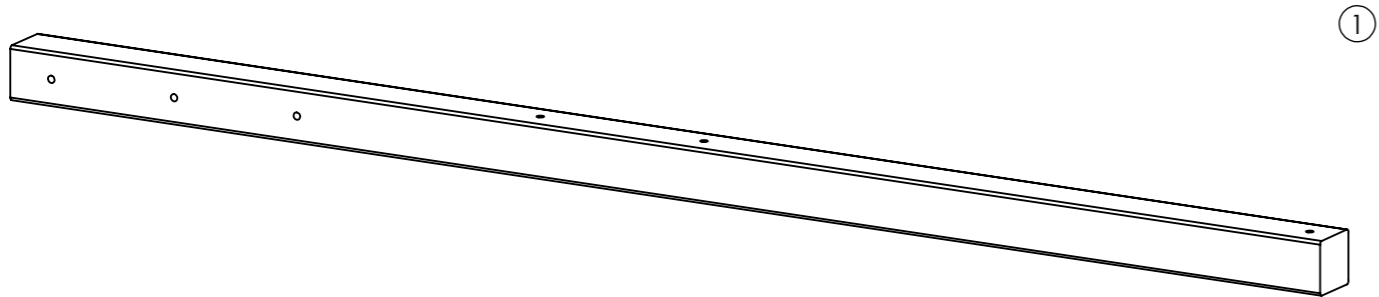

①

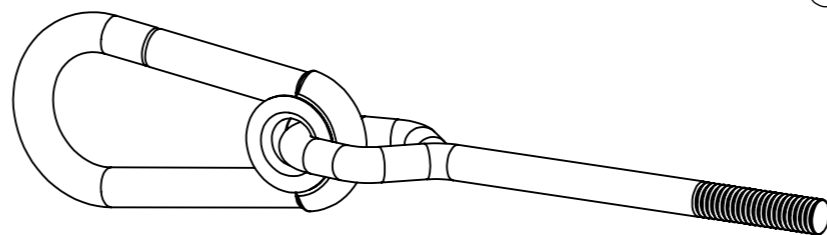

⑥

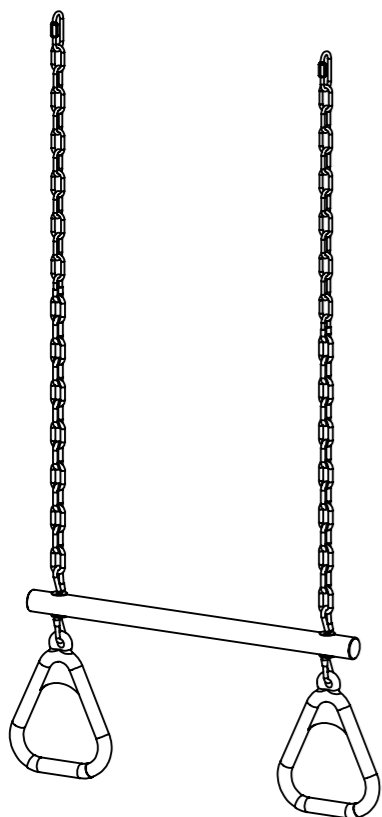

②

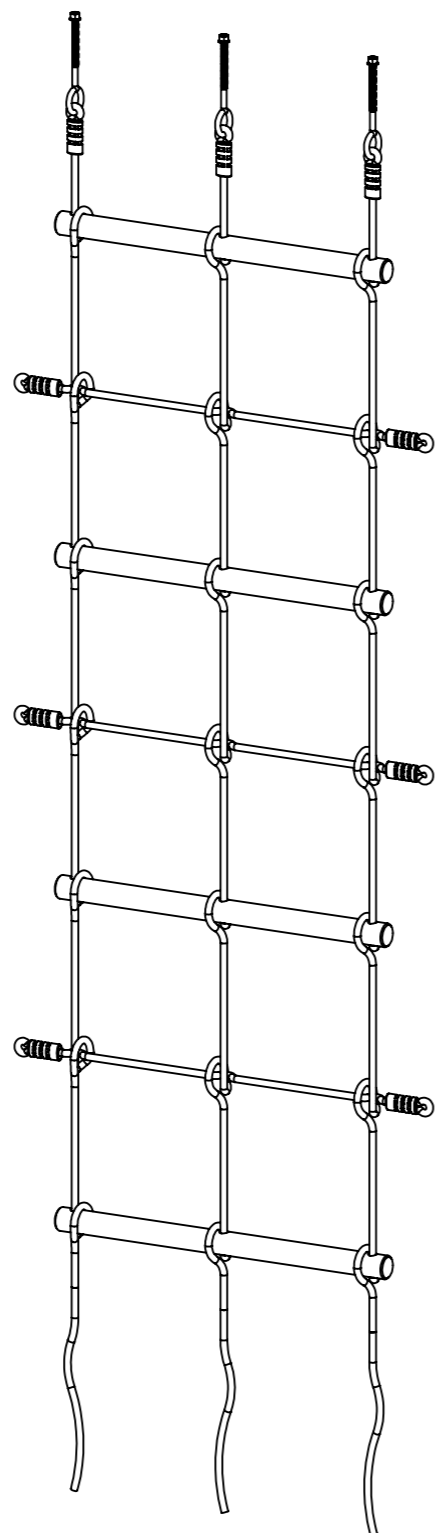

④

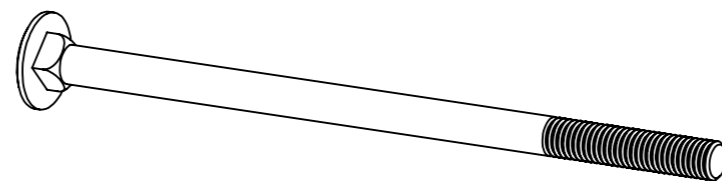

⑦

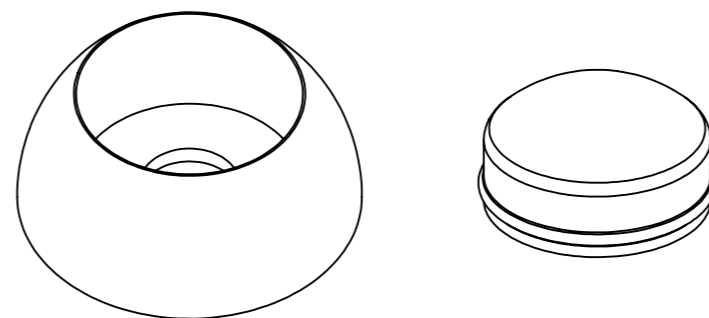

⑧

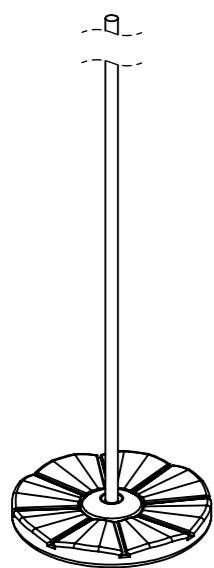

③

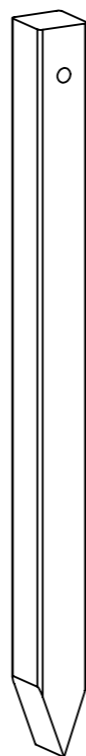

⑤

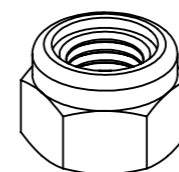

⑨

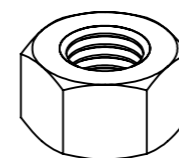

⑩

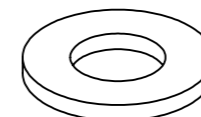

⑪

Cantilever Parts List		
Item	Description	Qty
1	Cantilever Beam	1
2	Trapeze Swing	1*
3	Pommel Swing	1*
4	Rope Ladder	1*
5	Wooden Peg	2**
6	Swing Hanger	2***
7	M10 x 200mm Coach Bolt	2
8	Fixing Protector Base & Cap Set	5
9	M10 Nyloc Hex Nut	2
10	M10 Hex Nut	2
11	M10 Flat Washer	4

* Based On Order
** Supplied With Rope Ladder Only
*** Supplied With Trapeze Swing Only

Tools Required	
1	13mm Spanner/Crescent/Socket
2	17mm Spanner/Crescent/Socket
3	Level
4	Hammer
5	Ladder

Additional Info
For Safety Reasons, Ensure Cantilever Beam Will Not Cross Over With Swing Paths Etc.

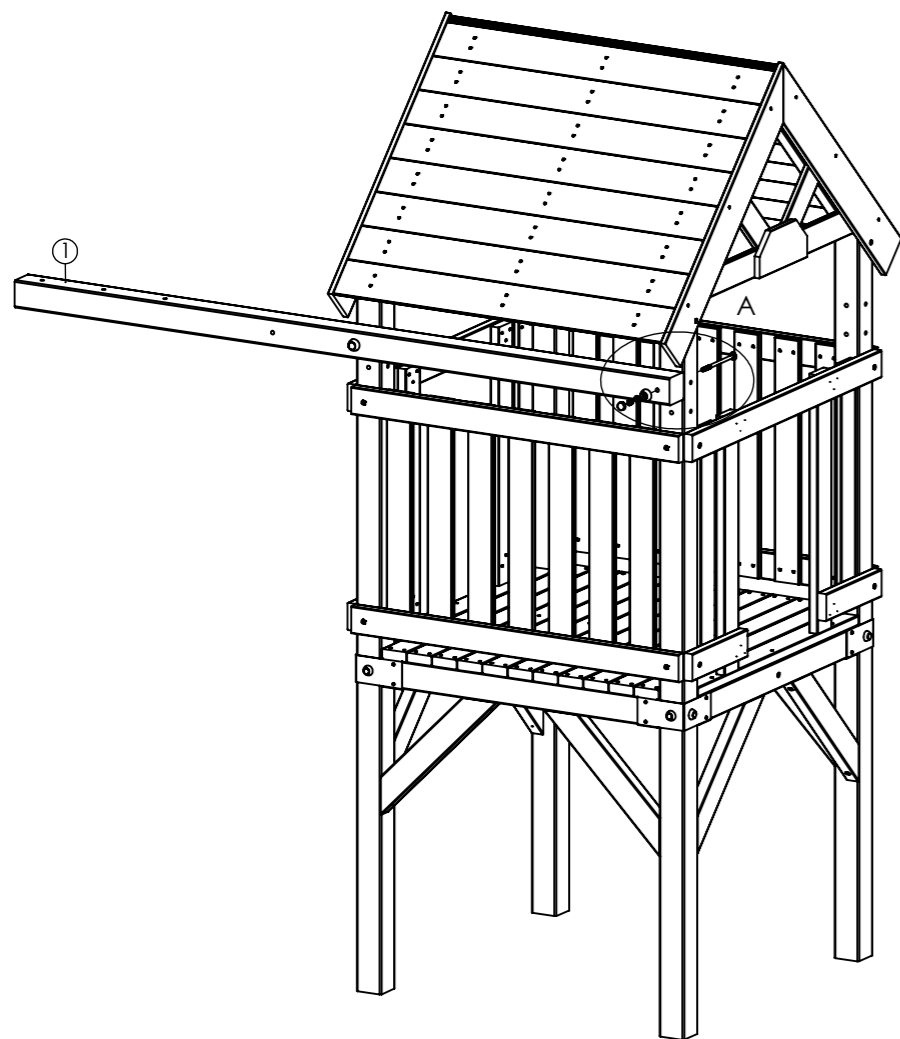

STEP:
Beam Installation

Instruction:
Fix Beam To Tower Holes At
Whichever Position Will Not
Interfere With Swing Beam Or
Monkey Bars As Per Detail A
(Ensure Beam Will Not Cross Over
With Swing Paths Etc).

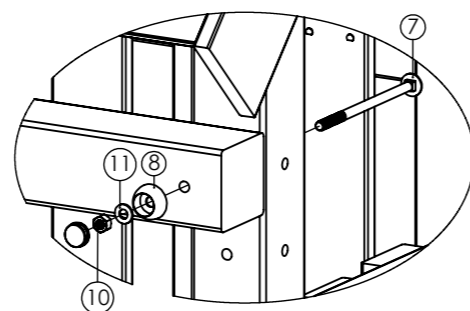

DETAIL A
SCALE 1 : 8

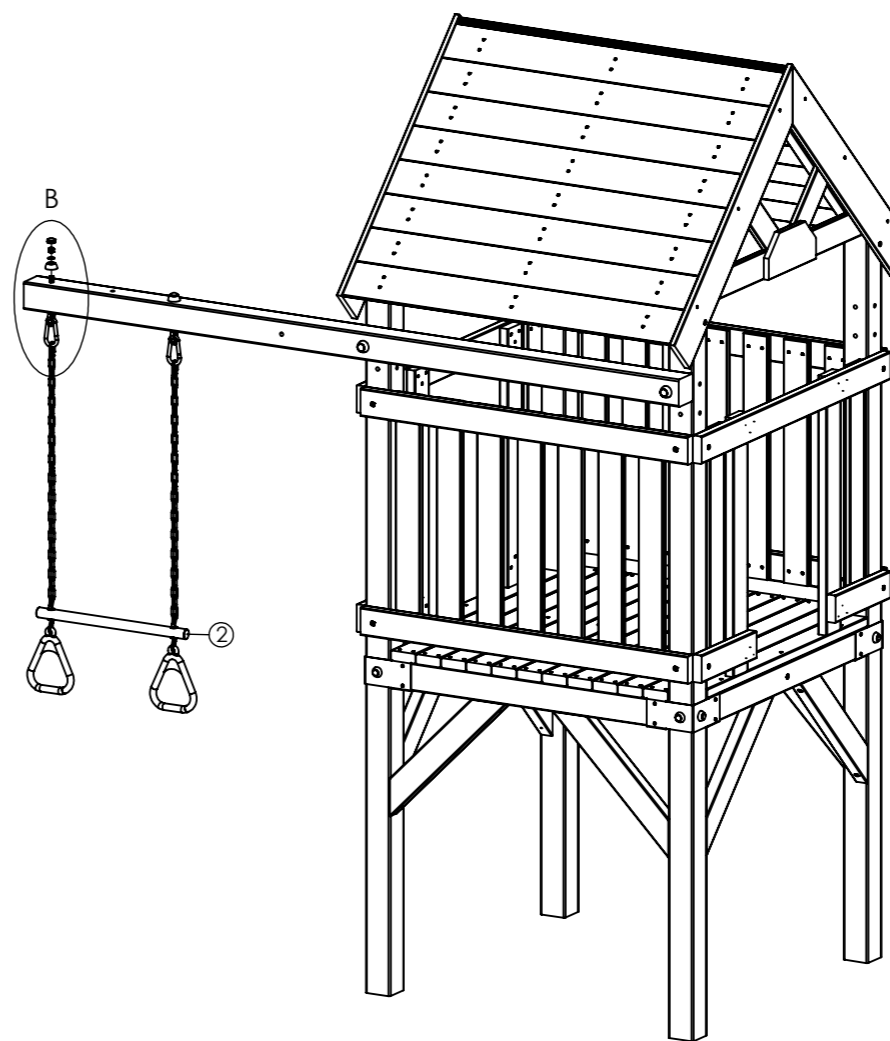

STEP:
Trapeze Swing Installation

Instruction:
Install Swing Hangers To
Cantilever Beam As Per Detail B.

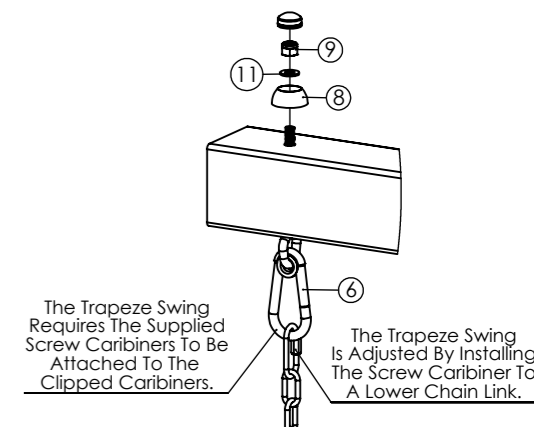

DETAIL B
SCALE 1 : 8

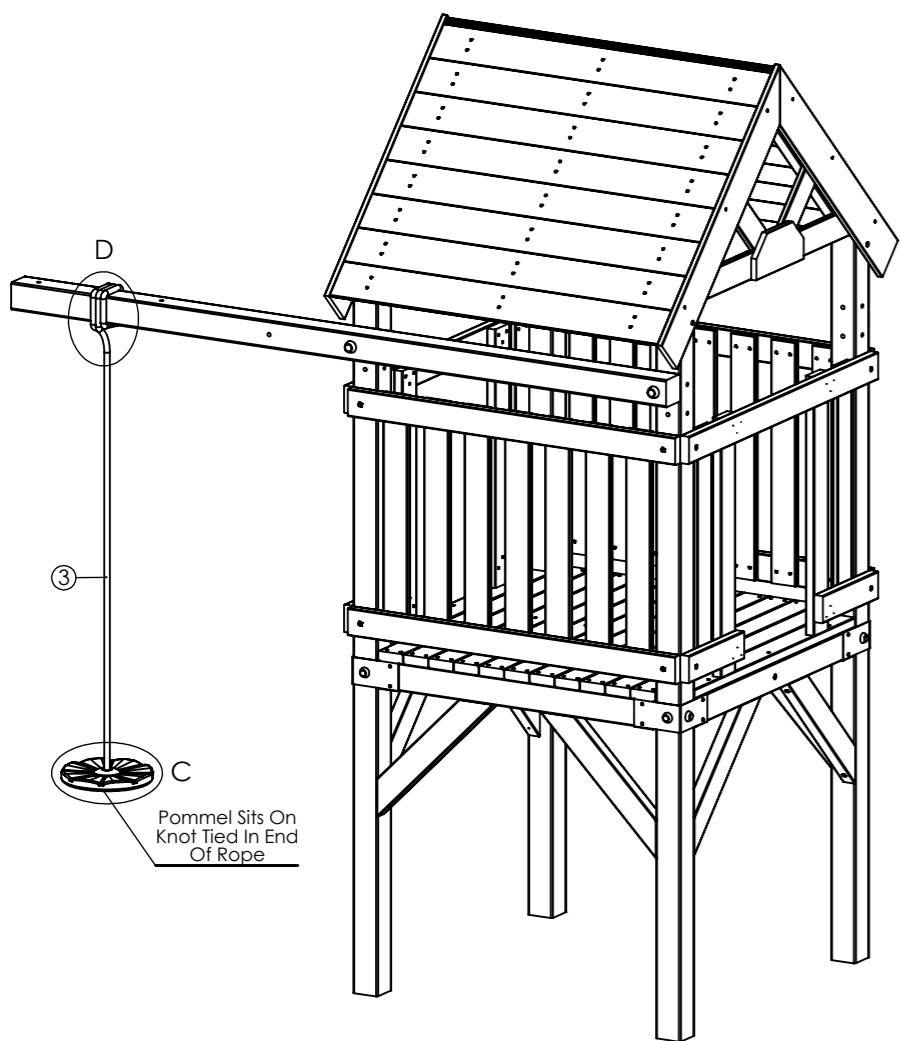

STEP:
Pommel Swing Installation

Instruction:
Tie A Sturdy Knot At The
Bottom Of The Supplied
Rope, Then Feed Rope
Through The Hole In The
Pommel Swing.
Set Swing Height, Then
Tie The Rope Securely
To The Cantilever Beam

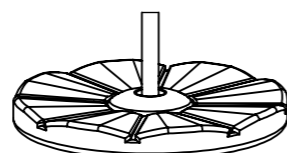

DETAIL C
SCALE 1 : 8

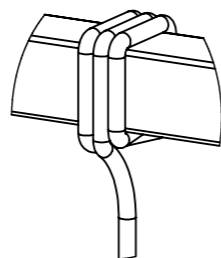

DETAIL D
SCALE 1 : 8

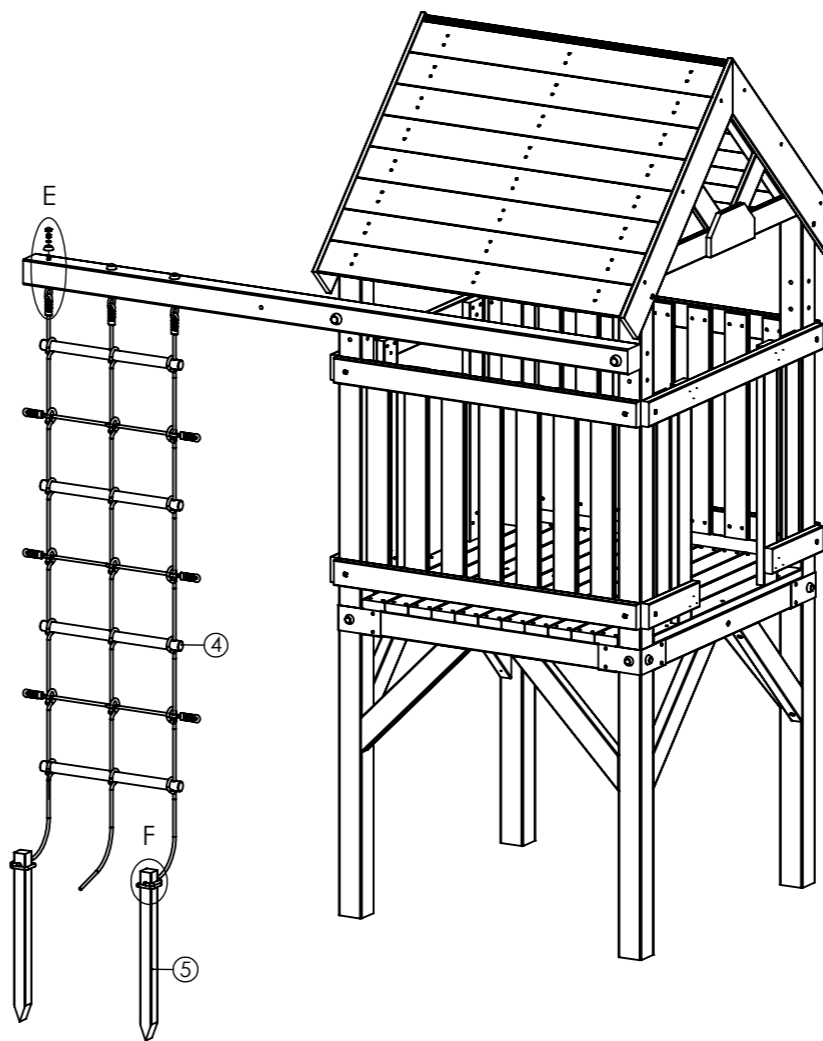

STEP:
Rope Ladder Installation

Instruction:
Fix Rope Ladder To Beam As
Per Detail E. Tie The Two Loose Outer
Rope Ends Through The Holes In
The Wooden Stakes. Hammer Stakes
Into The Ground Until They Are Roughly
50mm Above Ground. Bury The Middle
Loose Rope In The Ground.

M8 Fixings
Packaged With
Rope Ladder

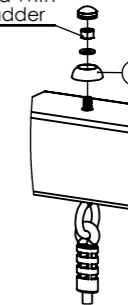

DETAIL E
SCALE 1 : 8

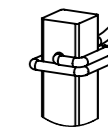

DETAIL F
SCALE 1 : 8